

Spherical roller bearings

R02	MA150119	GR150119
-----	----------	----------

22317 CAC3W33

Main boundary dimensions (mm)	
d	85
D	180
B	60

Technical data			
Basic load ratings (kN)	Dyn.	C_r	586
	Stat.	C_{0r}	617
Mass (kg)		7,65	
Cage material		Brass	
Radius min (mm)	r₁	3,0	
	r₂	3,0	
	r₃	-	
	r₄	-	
Precision class		P0	
e		0,33	
Bearing clearance (mm)		C3	

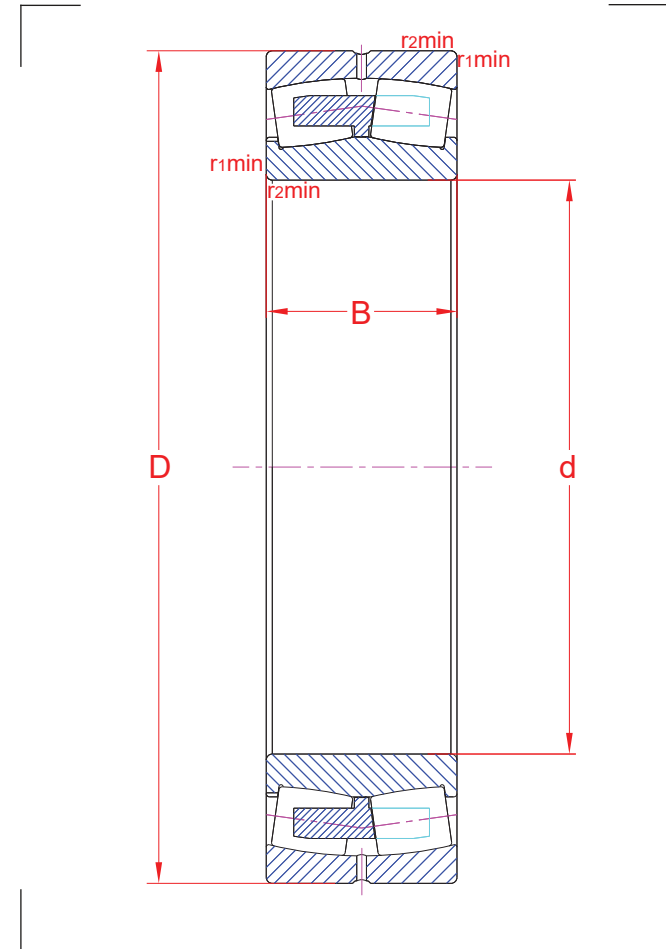

Technical notes

- Reference speed 2600 rpm
- Limiting speed 3400 rpm
- Double pronged machined brass cage
- Annular groove and lubrication holes in outer ring
- For general industry purpose

The sketch is for reference only and may not be representative or indicative of the actual product. Sketch scale is free.

Also refer to RKB Affidavit of Conformance for related compliance to International Standards.

Every care has been taken to ensure the accuracy of the information in the present drawing, but no liability can be accepted for any errors or omissions contained herein, or in case losses and/or damages (direct, indirect, consequential) should occur.

RKB Bearing Industries reserves the right of any amendment without notice.