

Deep groove ball bearings with seals

R02	GR050719	MA050719
-----	----------	----------

6203 2RSC3

Main boundary dimensions (mm)	
d	17
D	40
B	12

Technical data			
Basic load ratings (kN)	Dyn.	C_r	10,15
	Stat.	C_{0r}	4,73
Mass (kg)		0,068	
Cage material		Pressed steel	
Radius min (mm)	r₁	0,6	
	r₂	0,6	
	r₃	-	
	r₄	-	
Precision class		P0	
e		-	
Bearing clearance (mm)		C3	

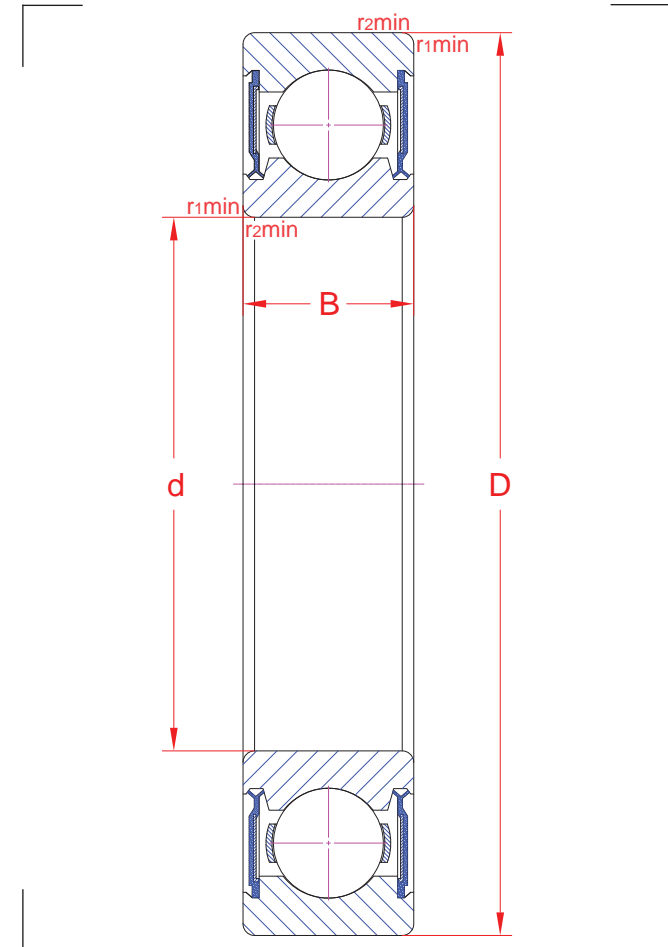

Technical notes

- Limiting speed 11300 rpm
- Contact seals on both sides
- Filled with standard bearing grease
- For general industry purpose

The sketch is for reference only and may not be representative or indicative of the actual product. Sketch scale is free.

Also refer to RKB Affidavit of Conformance for related compliance to International Standards.

Every care has been taken to ensure the accuracy of the information in the present drawing, but no liability can be accepted for any errors or omissions contained herein, or in case losses and/or damages (direct, indirect, consequential) should occur.

RKB Bearing Industries reserves the right of any amendment without notice.